

## Elektromagnenti releji LY serije



### Elektromagnetni releji opšte namjene LY serije

#### Tehničke karakteristike

	LY2	LY3	LY4
Tip releja	2 preklopna kontakta 8 pin	3 preklopna kontakta 11 pin	4 preklopna kontakta 14 pin
Otpornost kontakata	100 mΩ		
Struja kontakata	6A/250VAC 30VDC		
Vrijeme spajanja	25 ms max.		
Vrijeme rastavljanja	25 ms max.		
Max. radna frekvencija	Mehanička: 18000 operacija/h		
	Električna: 1800 operacija/h (sa nazivnim opterećenjem)		
Otpornost izolacije	1,000 MΩ min. (na 500 VDC)		
Dielektrična čvrstoća	1000 VAC, 50/60 Hz za 1 min između kontakata istog polariteta		
	2000 VAC, 50/60 Hz za 1 min između kontakata suprotnog polariteta		
Radna temperatura	-25 °C do 40 °C (bez smrzavanja)		
Vlažnost	5% do 85%		
Težina	cca 40 g		
Oznaka	N - signalizacija		
Standard	Omron		

### Nazivne vrijednosti kalema

Nazivni napon (V)	Nazivna struja (mA)	Otpornost kalema ( $\Omega$ )	Induktivnost kalema (H) (ref. vr.)		Napon spajanja	Napon rastavljanja	Max. napon	Potrošnja
			Arm. OFF	Arm. ON				
AC	12	106,5	46	0,17	0,33	30% min.	1- 1,2 VA	
	24	53,8	180	0,69	1,30			
	50	25,7	788	3,22	5,66			
	100/110	11,7/12,9	3750	14,54	24,6			
	220/240	4,8/5,3	18790	83,50	136,4			
DC	12	75	160	0,73	1,37	80% max.	10% min.	
	24	36,9	650	3,20	5,72			
	48	18,5	2600	10,60	21			
	100/110	9,1/10	11000	45,60	86,2			
							110%	0,9 W

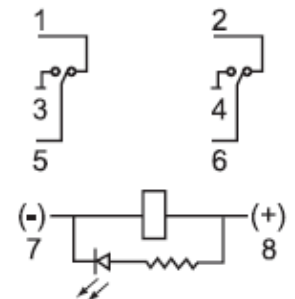
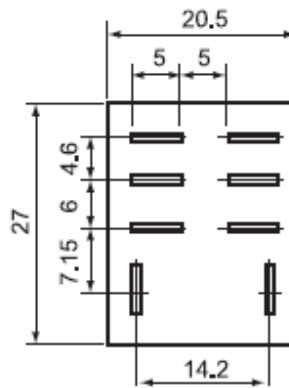
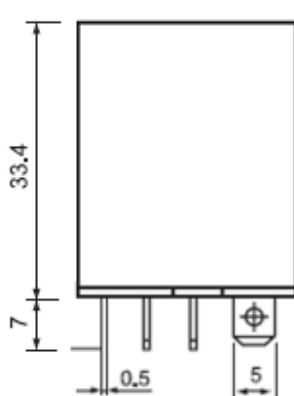

## Relaj LY2

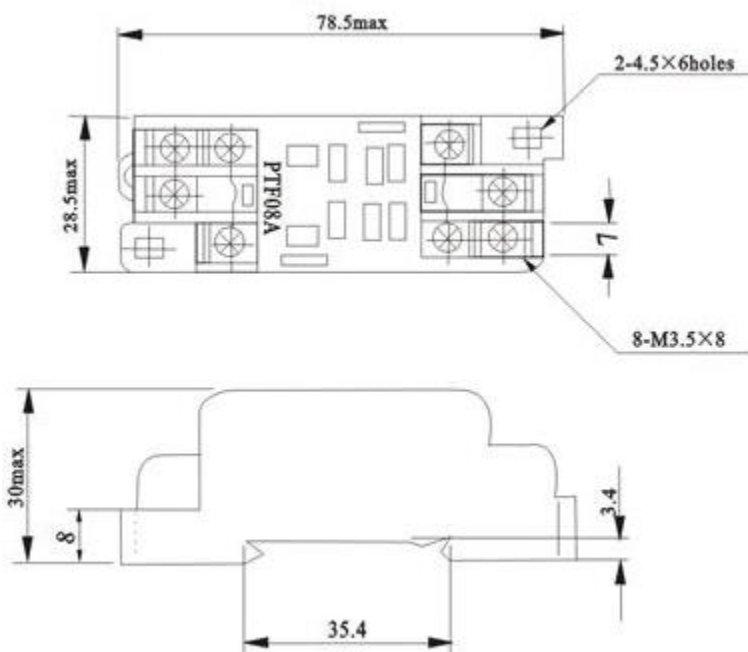

## Podnožje PTF08A

U ponudi imamo:

Tip releja	Napon kalema	Šifra
LY2	24VDC	15080137
LY2	24VAC	15080136
LY2	220VAC	15080138
Tip podnožja	Broj pinova	Šifra
PTF08A	8	15270017

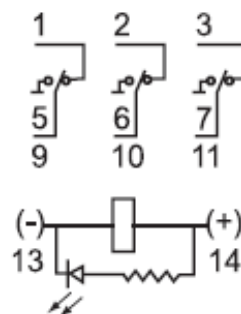
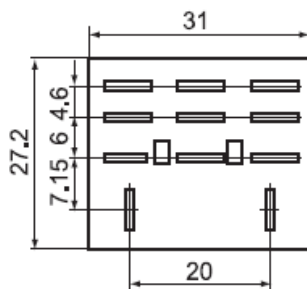
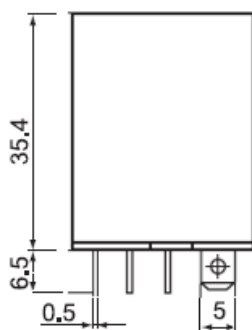

## Relaj LY3

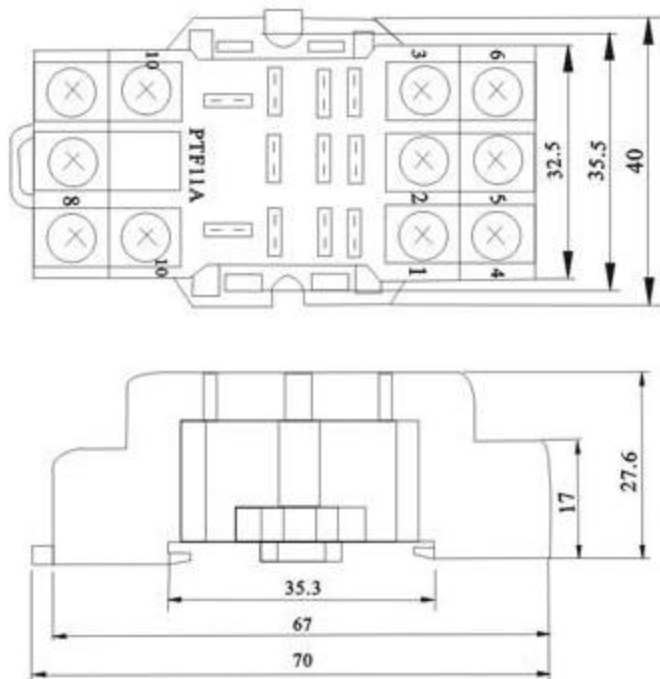

## Podnožje PTF11A

U ponudi imamo:

Tip releja	Napon kalema	Šifra
LY3	24VDC	15080139
LY3	220VAC	15080140
Tip podnožja	Broj pinova	Šifra
PTF11A	11	15270018

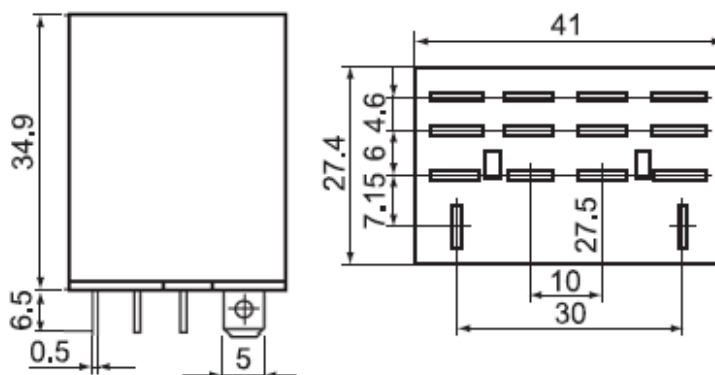

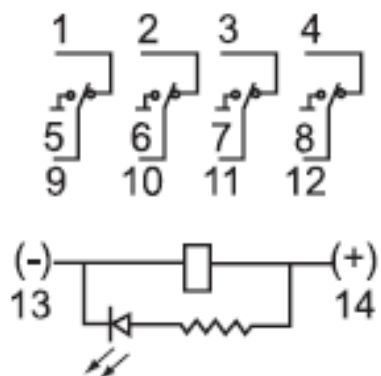

**Relej LY4**

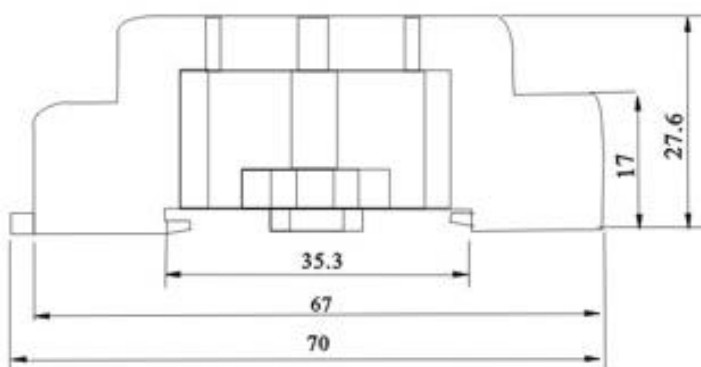
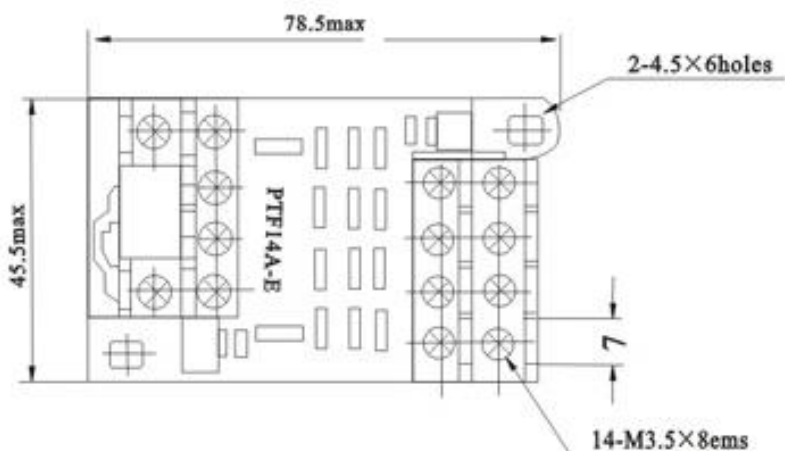

**Podnožje PTF14A**

U ponudi imamo:

Tip releja	Napon kalema	Šifra
LY4	24VDC	15080141
LY4	220VAC	15080142

Tip podnožja	Broj pinova	Šifra
PTF14A	14	15270019