

# HP Series Timer Relay user Manual



## Features:

- ⊙ Dual line 4 digit LED display;
- ⊙ High timing accuracy;
- ⊙ Range of setting time and delay time can be setted freely (11 kinds);
- ⊙ Multi-mounting size can be choosed;

## 1. Model Illustration

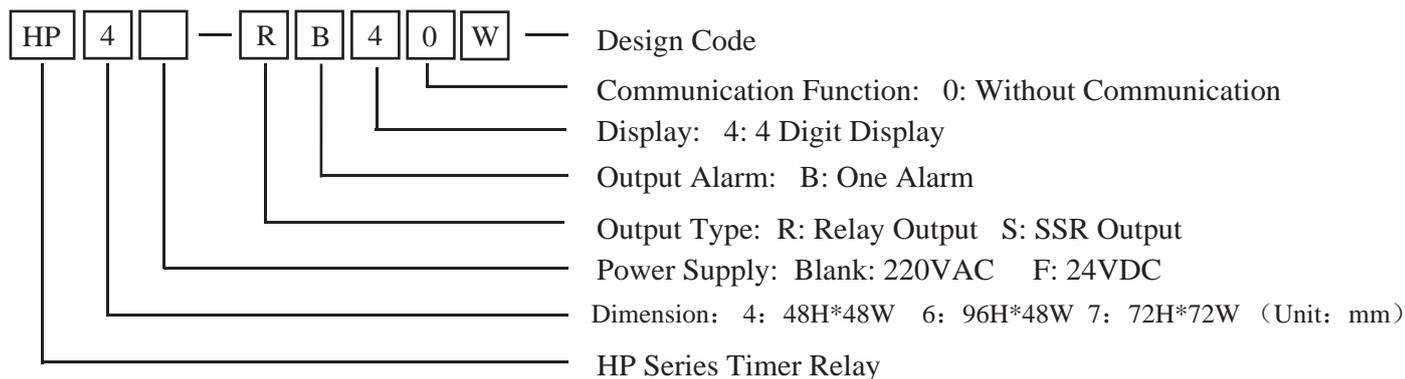

## 2. Ordering Code

Model	Display	Power Supply	Dimension (mm)	Alarm
HP4-RB40W	4	220VAC 50Hz	48H*48W	One
HP6-RB40W	4	220/110VAC±10% 50/60Hz	96H*48W	One
HP7-RB40W	4	220/110VAC±10% 50/60Hz	72H*72W	One

## 3. Technical Specification

Power Supply	220/110VAC±10% 50/60Hz (HP4 just for 220V power supply)
Power Consumption	≤3VA
Mounting Mode	Panel Mount
Timing Range	0.01-99.99S、0.1-999.9S、1-9999S、1-99M59S、0.01-99.99M、0.1-999.9M、1-9999M、1-99H59M、0.01-99.99H、0.1-999.9H、1-9999H
Timing Accuracy	±0.1%±0.05sec
Reset Mode	Panel reset, External Connection reset, Auto Reset or Power OFF Reset can be choosed
Input Signal	low level effective
Terminal Capacity	3A/250VAC or 6A/30VDC
Pulse Interference (AC)	±1.8KV
Dielectric	AC 1500V 1min
Insulation Impedance	DC 500V ≥ 100MΩ
Ambient Humidity	≤85% RH
Ambient Temperature	0~50℃

## 4. Panel Instruction

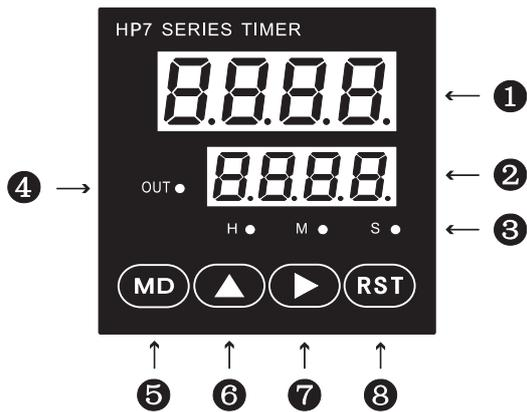

- ① :Timing Value Display Window
- ② :Setting Value Display Window
- ③ :Hour (H), Minute (M), Second (S) Indicate Light
- ④ :Relay Output Indicate Light
- ⑤ : Function, SET Key
- ⑥ :Increase Key
- ⑦ :Right Shift Key
- ⑧ : Reset Key

## 5. Operation Sequence

### ● Function Menu

Menu Sequence	Menu Function	Setting Range
<p>Timing Status</p> <p>MD &gt; 3S</p> <p>rAn1</p> <p>9999</p> <p>MD</p> <p>rAn2</p> <p>9999</p> <p>MD</p> <p>U-d</p> <p>888U</p> <p>MD</p> <p>int</p> <p>8820</p> <p>MD</p> <p>out</p> <p>888n</p> <p>MD</p> <p>StA</p> <p>88no</p> <p>MD</p> <p>Hold</p> <p>YES</p> <p>MD</p> <p>LoCK</p> <p>L-0</p> <p>MD</p>	<p>Under the condition of timing status, press <b>MD</b> more than 3S to enter into function menu, after parameter modification, press <b>MD</b> for a long time to back to timing status. If there is no any operation for more than 10S, the meter will return back to the timing status automatically (the modification will not be saved)</p> <p>rAn1 :Timing value range choose menu, lower line LED display Max timing value, H,M,S indicate light separately to show the relative units.</p> <p>rAn2 :Delay time range choose menu, lower line LED display Max delay time value, H,M,S indicate light separately to show the relative units. (F,N mode without this menu)</p> <p>U-d :Timing mode choose menu</p> <p>int : Effective pulse width of Input signal choose menu.</p> <p>out : Output Mode choose menu</p> <p>StA : Start function</p> <p>Hold : Power OFF data save choose menu</p> <p>LoCK : Lock key menu</p>	<p>99.99S → 999.9S → 9999S → 99M59S → 99.99M</p> <p>9999H ← 999.9H ← 99.99H ← 99H59M ← 9999M ← 999.9M</p> <p>99.99S → 999.9S → 9999S → 99M59S → 99.99M</p> <p>9999H ← 999.9H ← 99.99H ← 99H59M ← 9999M ← 999.9M</p> <p>U Add Timing Mode: Timing count value increase from 0 to setting value</p> <p>d Minus Timing Mode: Timing count value decrease from setting value to 0</p> <p>1 : 1mS</p> <p>20 : 20mS</p> <p>n : N Mode → F : F Mode</p> <p>↑</p> <p>↓</p> <p>C : C Mode ← r : R Mode</p> <p>YES : With start function, after power should press <b>▲</b> or short connect PAUSE terminal, the meter start to work.</p> <p>no : Without start function, the meter will work after power on.</p> <p>YES : Power Off Data save function</p> <p>no : Without Power Off Data save function</p> <p>L-0 : Without Lock function</p> <p>L-1 : Lock Panel reset</p> <p>L-2 : Lock setting value menu + function menu</p> <p>L-3 : Lock panel reset + setting value menu + function menu</p>

## ● Setting Value Modify Menu

Menu Sequence	Menu Function	Setting Range
	<p>Under the condition of Timing status, press  to enter into setting value modify menu.</p>	
	<p><b>t.off</b>: Relay Timing value setting menu When Timing value <math>\geq</math> T.off setting value, Relay ON.</p>	<p>The parameter can be setting freely between 0.01S-9999H according to the different timing range that you choosed in function menu <math>r \bar{A} \bar{n} \bar{l}</math></p>
	<p><b>t.on</b>: Output delay setting menu, relay will reset after Relay OFF time <math>\geq</math> T.on setting value. (N,F mode without this menu)</p>	<p>The parameter can be setting freely between 0.01S-9999H according to the different timing range that you choosed in function menu <math>r \bar{A} \bar{n} \bar{l}</math></p>

## 6. Dimensions (mm)

Panel Size

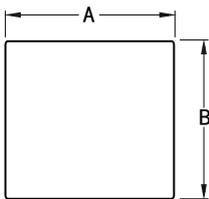

Side Face Size

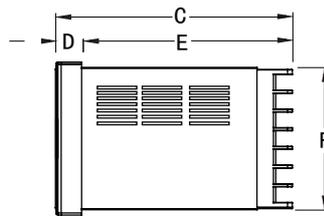

Mounting Size

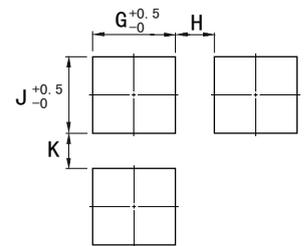

Model	A	B	C	D	E	F	G	H(Min)	J	K(Min)
4:(48*48)	48	48	97.5	6.5	91	45	45.5	25	45.5	25
6:(96*48)	48	96	97.5	9	88.5	89.5	45	25	90	25
7:(72*72)	72	72	97.5	9	88.5	67	67.5	25	67.5	25

## 7. Output Logic Table

F Mode	
Power	
Pause	
Reset	
Output	
Max Timing Value	
Setting Value T.off	
UP 0	
Setting Value T.off	
DOWN 0	

Timing Value continue to increase or decrease, output will be kept before input reset.

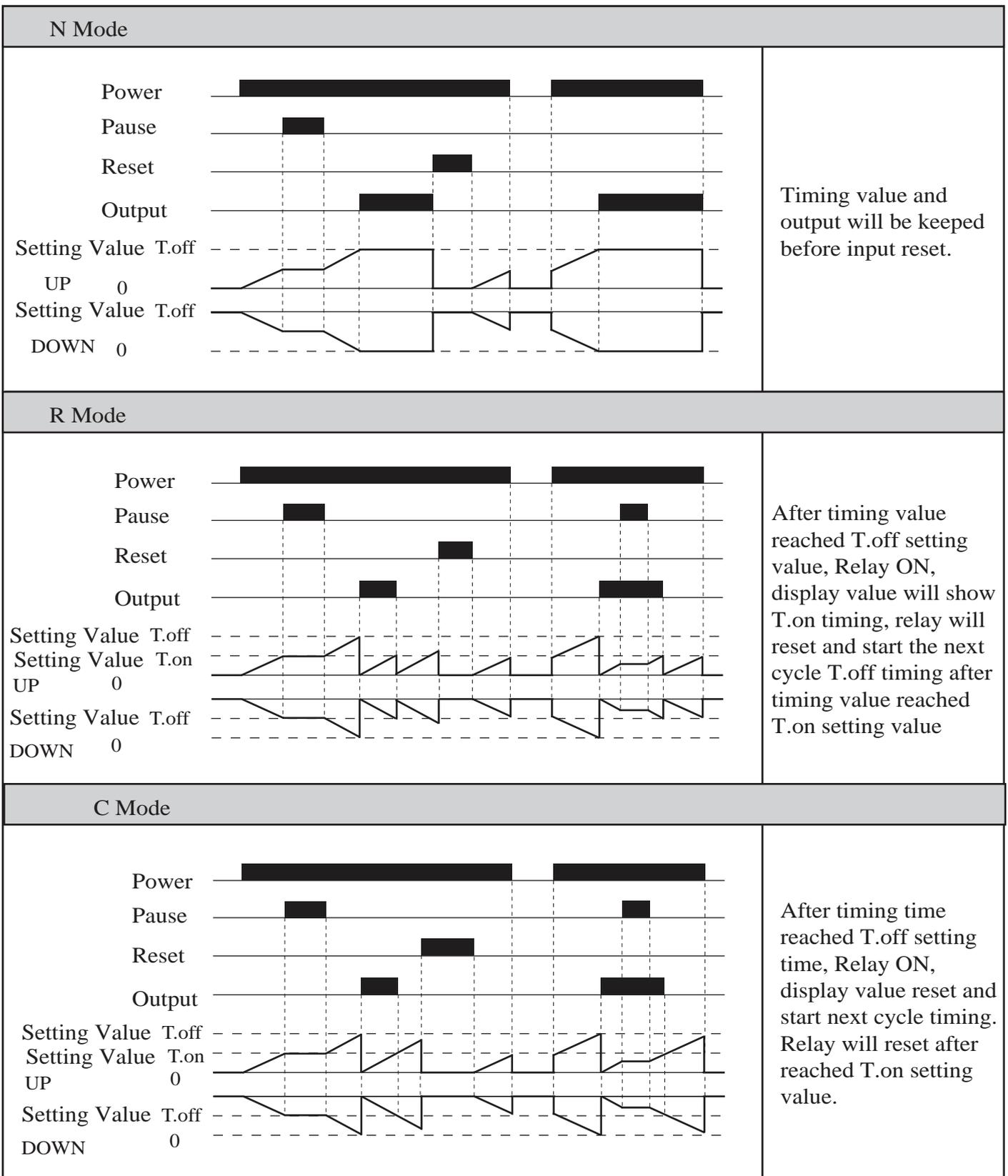

## 8. Connection Drawing

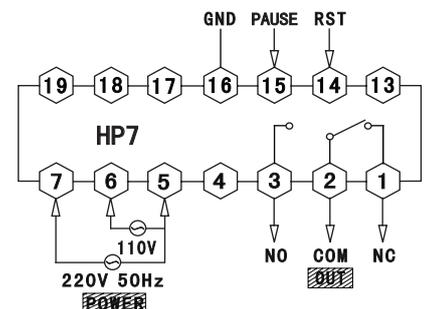
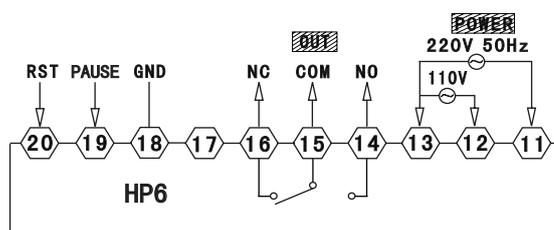
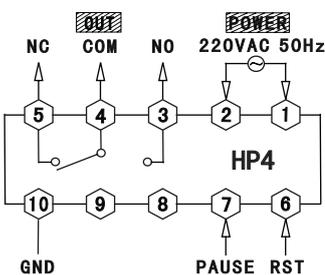

Note: If there is any change, please subject to the drawing on the meter!